

HTN-QF48 Datasheet

Technical Specifications

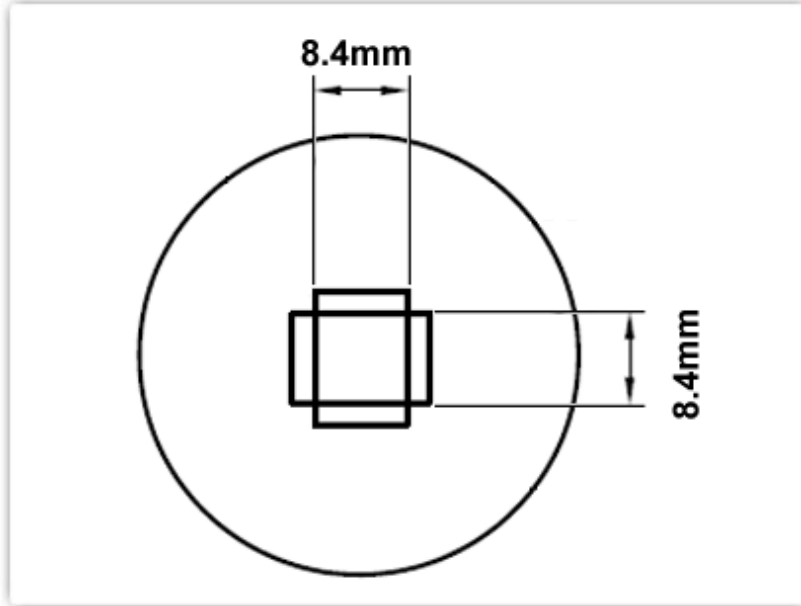

HTN-QF48

Nozzle 8.4mm x 8.4mm, QFP-48

Nozzle Style: QFP-48

Nozzle Width: 8.40mm (0.33")

Nozzle Height: 8.40mm (0.33")

Nozzle Type:	HTN Series
RoHS Compliant / Lead Free:	YES
Equivalent to:	H-Q07
For Use With:	TMT-HA200, TMT-HA300, HCT-900

Material Composition

Stainless Steel



**All components
are RoHS
compliant and
Lead-Free.**



**Standard Connector
22mm (0.87") diameter**